

THE PROPERTY OF THE DRAWING IS ESTABLISHED BY LAW. IT IS FORBIDDEN TO PRODUCE OR SHOW IT TO THIRD PART. WITHOUT A WRITTEN AGREEMENT.

Item	Name	Q.ty
1	CA.08.09.021	1
2	CA.08.26.D53.AS	1

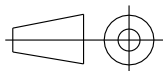
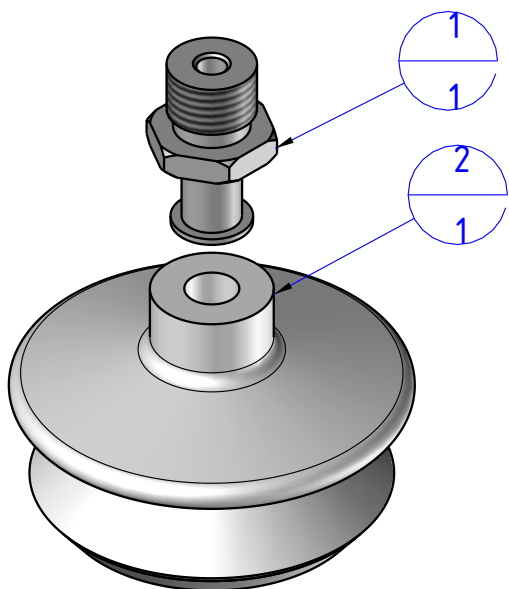
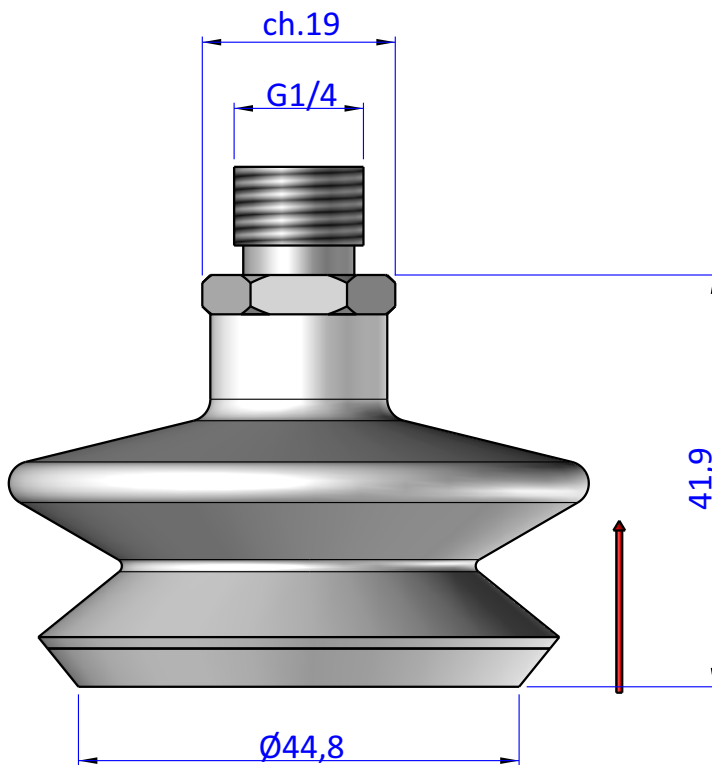

DESIGNED FROM	REVIEW
FPS Automation	A

DATE	WEIGHT
04/11/2020	0,038kg

CODE
KIT.08.26.D53.21

Format A4

UNI 936-76

GENERAL TOLERANCE

UNI - ISO 2768

CLASSE f

DESCRIPTION

KIT.08.26.D53.21